

**DC1000 Series
Digital Controller
Product Manual**

51-52-25-113

August 2005

Copyright, Notices and Trademarks

Printed in Taiwan - © Copyright 2005 by Honeywell

Revision 1 - August 2005

WARRANTY/REMEDY

Honeywell warrants goods of its manufacture as being free of defective materials and faulty workmanship. Contact your local sales office for warranty information. If warranted goods are returned to Honeywell during the period of coverage, Honeywell will repair or replace without charge those items it finds defective. The foregoing is Buyer's sole remedy and is **in lieu of all other warranties, expressed or implied, including those of merchantability and fitness for a particular purpose**. Specifications may change without notice. The information we supply is believed to be accurate and reliable as of this printing. However, we assume no responsibility for its use.

While we provide application assistance personally, through our literature and the Honeywell web site, it is up to the customer to determine the suitability of the product in the application.

Industrial Measurement and Control

Honeywell Korea

191 HanGangRo 2ga, YongSanGu

Seoul, Korea

About This Document

Abstract

This document provides descriptions and procedures for the Installation, Configuration, and Operation of your DC1000 Controller.

Contacts

World Wide Web

The following lists Honeywell's World Wide Web sites that will be of interest to our customers.

Honeywell Organization	WWW Address (URL)
Corporate	http://www.honeywell.com
Industrial Measurement and Control	http://www.honeywell.com/imc









Telephone

Contact us by telephone at the numbers listed below.

	Organization	Phone Number
United States and Canada	Honeywell	1-800-423-9883 Tech. Support 1-800-525-7439 Service
Asia Pacific	Asia Pacific Headquarters	(63-2) 633 2830
Europe	Honeywell PACE, Brussels, Belgium	Contact your Local Sales Office
Latin America	Honeywell, Ft. Washington, PA U.S.A.	215-641-3610

Symbol Definitions

The following table lists those symbols used in this document to denote certain conditions.

Symbol	Definition
	This CAUTION symbol on the equipment refers the user to the Product Manual for additional information. This symbol appears next to required information in the manual.
	WARNING PERSONAL INJURY: Risk of electrical shock. This symbol warns the user of a potential shock hazard where HAZARDOUS LIVE voltages greater than 30 Vrms, 42.4 Vpeak, or 60 VDC may be accessible. Failure to comply with these instructions could result in death or serious injury.
	ATTENTION, Electrostatic Discharge (ESD) hazards. Observe precautions for handling electrostatic sensitive devices
	Protective Earth (PE) terminal. Provided for connection of the protective earth (green or green/yellow) supply system conductor.
	Functional earth terminal. Used for non-safety purposes such as noise immunity improvement. NOTE: This connection shall be bonded to protective earth at the source of supply in accordance with national local electrical code requirements.
	Earth Ground. Functional earth connection. NOTE: This connection shall be bonded to Protective earth at the source of supply in accordance with national and local electrical code requirements.
	Chassis Ground. Identifies a connection to the chassis or frame of the equipment shall be bonded to Protective Earth at the source of supply in accordance with national and local electrical code requirements.
	Equipment protected throughout by DOUBLE INSULATION or REINFORCED INSULATION

Contents

1	INTRODUCTION	1
1.1	Overview.....	1
2	INSTALLATION.....	3
2.1	Overview.....	3
2.2	Condensed Specifications	4
2.3	Model Number Interpretation	6
2.4	Mounting.....	8
2.4.1	Physical Considerations	8
2.4.2	Overall Dimensions.....	8
2.4.3	Mounting Procedure.....	10
2.5	Wiring.....	11
2.5.1	Electrical Considerations	11
2.6	Wiring Diagrams.....	12
2.6.1	Identify Your Wiring Requirements	12
2.6.2	Making Terminal Connections.....	12
2.6.3	Wiring Diagrams.....	13
3	OPERATION.....	17
3.1	Overview.....	17
3.2	Operator Interface Overview	17
3.2.1	Displays, LEDs, and Keys	18
3.3	Mode Access.....	19
3.3.1	How to move from one mode to another.....	19
3.4	Operation Mode	20
3.4.1	Key Functions	20
3.4.2	Operation Mode Prompts	20
3.4.3	Control Types.....	21
3.4.4	Set Point.....	22
3.4.5	Alarm Functions and Associated Prompts	23
4	CONFIGURATION.....	24
4.1	Introduction.....	24
4.2	Configuration 1	24
4.2.1	Configuration 2	26
4.3	ALARMS CONFIGURATION	29
4.3.1	Alarm Function Selections.....	29
4.3.2	Deviation Alarm Overview	30
4.3.3	Absolute Value Alarm Overview.....	32
4.3.4	Program Alarm.....	33

- 4.3.5 System Alarm.....33
- 4.4 Function Lock.....34
- 4.5 Parameter Display Set (Hide or Display).....35
 - 4.5.1 Overview.....35
 - 4.5.2 Functions of SETs.....35
- 4.6 Input Codes.....37
 - 4.6.1 Code Selection.....37
- 5 PROGRAMMER (OPTIONAL) 41**
 - 5.1 Overview.....41
 - 5.1.1 Introduction.....41
 - 5.2 Programmer Terminologies.....41
 - 5.3 Operating Key Functions.....41
 - 5.4 Program Functions.....41
 - 5.4.1 Program Running Alarm.....41
 - 5.4.2 Segment Completion Alarm.....42
 - 5.4.3 END Function.....42
 - 5.4.4 Linking Function.....42
 - 5.4.5 Wait Function.....42
 - 5.4.6 Other Functions.....43
 - 5.5 Program Configuration Prompts.....44
 - 5.5.1 Overview.....44
 - 5.5.2 Configuration.....44
 - 5.5.3 Program Example.....47
- 6 ERROR CODES 48**
 - 6.1 Overview.....48
- 7 INDEX..... 49**

Tables

Table 2-1 Condensed Specifications	4
Table 3-1 Displays, LEDs, and Keys	18
Table 3-2 Mode Change Instructions	19
Table 3-3 Operation Mode Prompts	20
Table 4-1 Configuration 1 Mode	24
Table 4-2 Configuration 2 Mode	26
Table 4-3 Alarm Function Selections	29
Table 4-4 Functions of Sets	35
Table 4-5 Thermocouple Inputs	37
Table 4-6 RTD Inputs	38
Table 4-7 Linear Inputs	39
Table 5-1 Key Functions	41
Table 5-2 Associated Program Functions	43
Table 5-3 Program Configuration Prompts	44
Table 6-1 Error Codes	48

Figures

Figure 2-1 Model DC1010 Dimensions _____	8
Figure 2-2 Model DC1020 Dimensions _____	8
Figure 2-3 Model DC1030 Dimensions _____	9
Figure 2-4 Model DC1040 Dimensions _____	9
Figure 2-5 Mounting Procedure _____	10
Figure 2-6 Model DC1010 Wiring _____	13
Figure 2-7 Model DC1020, DC1025 Wiring _____	14
Figure 2-8 Model DC1030 Wiring _____	15
Figure 2-9 Model DC1040 Wiring _____	16
Figure 3-1 Operator Interface _____	17
Figure 3-2 Mode Access Diagram _____	19
Figure 4-1 Deviation Alarms _____	30
Figure 4-2 Upper Limit Deviation Alarm (Alarm Code 01, Alarm release in the first alarming situation) ____	30
Figure 4-3 Upper Limit Deviation Alarm (Alarm Code 11, No alarm release in the first alarming situation) _	30
Figure 4-4 Lower Limit Deviation Alarm (Alarm Code 02, Alarm release in the first alarming situation) ____	31
Figure 4-5 Lower Limit Deviation Alarm (Alarm Code 12, No alarm release in the first alarming situation) _	31
Figure 4-6 Dev. Band Breakaway Alarm (Alarm Code 03, Alarm release in the first alarming situation) _____	31
Figure 4-7 Dev. Band Breakaway Alarm (Alarm Code 13, No alarm release in the first alarming situation) __	31
Figure 4-8 Deviation Band Alarm (Alarm Code 04, Alarm release in the first alarming situation) _____	31
Figure 4-9 Deviation Band Alarm (Alarm Code 14, No alarm release in the first alarming situation) _____	31
Figure 4-10 Absolute Value Alarm _____	32
Figure 4-11 Absolute Upper Limit Alarm (Alarm Code 05, Alarm release in the first alarming situation) ____	32
Figure 4-12 Absolute Upper Limit Alarm (Alarm Code 15, No alarm release in the first alarming situation) _	32
Figure 4-13 Absolute Lower Limit Alarm (Alarm Code 06, Alarm release in the first alarming situation) ____	32
Figure 4-14 Absolute Lower Limit Alarm (Alarm Code 16, No alarm release in the first alarming situation) _	32
Figure 4-15 Program RUN Alarm – Code 17 _____	33
Figure 4-16 System Error Alarm – Code 08 _____	33
Figure 4-17 System Error Alarm – Code 18 _____	33
Figure 4-18 Display Status _____	35
Figure 5-1 Program Example _____	47

1 Introduction

1.1 Overview

Function

The DC1000 family of microprocessor-based controllers combine a high degree of functionality and reliability in 4 different formats: 1/16 DIN, 1/8 DIN, 3/16 DIN, and 1/4 DIN.



With a typical accuracy of $\pm 0.5\%$ of span, the DC1000 is an ideal controller for regulating temperature and other process variables in a variety of applications including dryers, semiconductor packaging & testing, plastic processing, packaging machinery, painting & coating, and climatic chambers.

Easy to Configure

Two different configuration levels provide easy access to parameters. A 4-digit security code prevents unauthorized changes. Parameters can also be hidden to the user to prevent unauthorized configuration of the unit.

Various Control Algorithms

The DC1000 series of controllers provides several different algorithms:

- PID or ON/OFF Control
- Heat/Cool Algorithms with 2 different PID sets
- Motor Position Control without slidewire feedback
- Single Phase Control with/without zero crossover control
- Three Phase Control with/without zero crossover control

Mount Anywhere

The DC1000 controller family is industrial control equipment that must be panel mounted. The wiring terminals must be enclosed within the panel. The DC1000 is environmentally hardened and, when suitably enclosed, can be mounted virtually anywhere in a plant or factory; on a wall, in a panel, or even on the process machine. It withstands ambient temperature of up to 50°C (122°F).

CE Conformity (Europe)

This product is in conformity with the protection requirements of the following: European Council Directive; **73/23/EEC** - the Low Voltage Directive, and **89/336/EEC** - the EMC Directive. Conformity of this product with any other “CE Mark” Directive(s) shall not be assumed.

Enclosure Rating: Panel-mounted equipment, IP00. This controller must be panel mounted. Terminals must be enclosed within panel. Front panel IP65 (IEC 529) optionally.

2 Installation

2.1 Overview

Introduction

Installation of the DC1000 consists of mounting and wiring the controller according to the instructions given in this section. Read the pre-installation information, check the model number interpretation (Subsection 2.3), and become familiar with your model selections, then proceed with installation.



CAUTION

Installation should be performed only by personnel who are technically competent to do so. Local Regulations regarding electrical & safety must be observed.

Pre-installation Information

If the controller has not been removed from its shipping carton, inspect the carton for damage then remove the controller.

- Inspect the unit for any obvious shipping damage and report any damage due to transit to the carrier.
- Make sure a bag containing mounting hardware is included in the carton with the controller.
- Check that the model number shown on the inside of the case agrees with what you have ordered.

2.2 Condensed Specifications

Honeywell recommends that you review and adhere to the operating limits listed in Table 2-1 when you install your controller.

Table 2-1 Condensed Specifications

TECHNICAL DATA		
PV Input	Type of Input	TC (K, J, R, S, B, E, N, T, W, PL II, U, L) RTD (Pt100Ω, JPt100Ω, JPt50Ω) Linear (4 – 20mA)
	Input Sampling Time	500 ms
	Input Resolution	14 bit (each)
Indication	PV/SP Indication	4-digit, 7 segment display
	Constant Value Storage System	Non-volatile memory (EEPROM)
	Indication Accuracy	± 0.5%FS
Control Mode	Proportional Band (P)	0~200% (On/Off action at P=0)
	Integral Time (I)	0~3600 sec (PD action at I=0)
	Derivative Time (D)	0~900 sec (PI action at D=0)
	Cycle Time	0~150 sec (4~20mA → 0, SSR → 1, relay → 10)
Output	Relay Output	Contact, SPST(DC1010)/SPDT(1020,1030,1040), 3A/240VAC
	Voltage Output	Voltage Pulse, 20VDC/20mA
	Linear Output	4~20mA, 0~5V, 0~10V, 1~5V, 2~10V
	Motor Control Output	Three Position Step Control (Time proportional motor control)
	Others	1φ SSR, 3φ SSR, 1φ SCR, 3φ SCR
Alarm	Channel	3 channels (optional)
	Mode	17 alarm mode available
	Timer	Flicker alarm, continued alarm, on delay timer alarm
Aux. Output	Output Signal	SP, PV
	Type of Output	4~20mA, 0~20mA, 0~5V, 0~10V, 1~5V, 2~10V
2 nd Input (RSP)	Type of Input	4~20mA, 0~20mA, 0~5V, 0~10V, 1~5V, 2~10V
	Sampling Time	500 ms
Program	Pattern/Segment	2 pattern/ 8 segment (each)
	Availability	Pattern link & repeat, program/segment end alarm
Communication	Type of Communication	RS-232, RS-485
General Specifications	Rated Power Supply Voltage & Frequency	AC 100-240V, 50/60Hz or DC15-50V, 4VA
	Power Consumption	Max. 8VA
	Storage Temperature	-25°C~65°C
	Ambient Temperature	0°C~50°C
	Ambient Humidity	50~85% RH (no condensation)

INPUT ACTUATIONS			
TC	K		0.0~200.0, 400.0, 600, 800, 1000, 1200 °C
	J		0.0~200.0, 400.0, 600, 800, 1000, 1200 °C
	R		0.0~1600, 1769 °C
	S		0.0~1600, 1769 °C
	B		0.0~1820 °C
	E		0.0~800, 1000 °C
	N		0.0~1200,1300 °C
	T		0.0~400.0, 200.0 °C, 0.0~350.0 °C
	W		0.0~2000, 2320 °C
	PL II		0.0~1300, 1390 °C
	U		-199.9~600.0, 200.0 °C, 0.0~400.0 °C
	L		0.0~400.0, 800.0 °C
RTD	Pt100		-199.9~600.0, 400.0, 200.0 °C, 0.0~200.0, 400.0, 600.0 °C
	JPt100		-199.9~600.0, 400.0, 200.0 °C, 0.0~200.0, 400.0, 600.0 °C
	JPt50		-199.9~600.0, 400.0, 200.0 °C, 0.0~200.0, 400.0, 600.0 °C
Linear	AN4	0~50mV	0~20mA, 0~1V, 0~5V, 0~10V 4~20mA, 1~5V, 2~10V
	AN5	10~50mV	

2.3 Model Number Interpretation

Introduction

Write your controller's model number in the spaces provided below and circle the corresponding items in each table. This information will also be useful when you wire your controller.

Instructions

- Select the desired **Key Number**. The arrow to the right marks the selections available.
- Make one selection each from **Tables I through III** using the column below the proper arrow.
- A dot (•) denotes unrestricted availability. A letter denotes restricted availability.

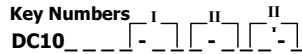

KEY NUMBER

KEY NUMBER	Description	Selection	Availability
Size	48 x 48 mm (DIN) 1/16)	DC1010_ _	↓
	48 x 96 mm (DIN 1/8)	DC1020_ _	↓
	72 x 72 mm	DC1030_ _	↓
	96 x 96 (DIN 1/4)	DC1040_ _	↓
Power	90-240 Vac Power	DC10_0_ _	• • • •
	15-50 Vdc Power	DC10_1_ _	b b b b
	90-240 Vac Power / IP 65	DC10_2_ _	• • • •
	15-50 Vac Power / IP65	DC10_3_ _	b b b b
	90-240 Vac Power / UL Agency Approval	DC10_4_ _	• • • •
15-50 Vdc Power / UL Agency Approval	DC10_5_ _	b b b b	
Program	None	DC10_ _C_	• • • •
	Program (2 patterns, 8 segments per 1 pattern)	DC10_ _P_	• • • •
Input	RTD	DC10_ _ _R	• • • •
	TC	DC10_ _ _T	• • • •
	Linear	DC10_ _ _L	• • • •

TABLE I

Control Output 1	None	0_ _	• • • •
	Relay, Contact, SPDT, 3A / 240 VAC	1_ _	• • • •
	Volt, Voltage Pulse, 20VDC / 20 mA	2_ _	• • • •
	mA Current, 4-20mA	3_ _	• • • •
	Open loop circuit servo motor control	7_ _	• c d c •
	0-5 V	A_ _	• • • •
	0-10 V	B_ _	• • • •
	1-5 V	C_ _	• • • •
	2-10 V	D_ _	• • • •
	Control Output 2 (Heat/Cool)	None	_0_
Relay, Contact, SPDT, 3A / 240VAC		_1_	• • • •
Volt, Voltage Pulse, 20VDC / 20mA		_2_	• • • •
mA Current, 4-20mA		_3_	• • • •
0-5V		_A_	• • • •
0-10V		_B_	• • • •
1-5V		_C_	• • • •
2-10V		_D_	• • • •
Alarm Event	1 Alarm Relay	_ _1	e • i •
	2 Alarm Relays	_ _2	f g j •
	3 Alarm Relays	_ _3	h k

Table II			Availability				
			DC10	10	20	30	40
			Selection	↓	↓	↓	↓
Transmitter	None	0 _ _	•	•	•	•	
	4-20 mA	1 _ _	•	•	•	•	
	0-20 mA	2 _ _	•	•	•	•	
	0-5 V	A _ _	•	•	•	•	
	0-10 V	B _ _	•	•	•	•	
	1-5 V	C _ _	•	•	•	•	
	2-10 V	D _ _	•	•	•	•	
	Remote SP	None	_ 0 _	•	•	•	•
4-20 mA		_ 1 _					
0-20 mA		_ 2 _					
0-5 V		_ A _					
0-10 V		_ B _					
1-5 V		_ C _					
2-10 V		_ D _					
Communication		None	_ _ 0	•	•	•	•
	RS-232	_ _ 1	m	n	•	•	
	RS-485	_ _ 2	m	n	•	•	

TABLE III

Manual	English	E	•	•	•	•
	Chinese	C				
	French	F				
	Korean	K	•	•	•	•

RESTRICTIONS / NOTES

Restriction Letter	Available Only With		Not Available With	
	Table	Selection	Table	Selection
b			II	X _ _
c	I	_ 0 1, _ 0 2		
d	I & II	DC10 _ _ _ _ - _ 0 1 - _ 0 _ - _		
e			I & II	DC10 _ _ _ _ - _ X _ - 0 _ 2 - _
f			I & II	DC10 _ _ _ _ - _ X _ - X _ 0 - _
g			I & II II	DC10 _ _ _ _ - _ X _ - X _ _ - _ X _ X
h	I & II	DC10 _ _ _ _ - _ 0 _ - 0 _ 0 - _		
i			I & II	DC10 _ _ _ _ - _ X _ - _ X _ - _
j	I & II	DC10 _ _ _ _ - _ 0 _ - _ 0 _ - _		
k	I & II	DC10 _ _ _ _ - _ 0 _ - _ _ 0 - _		
l				DC10 _ _ _ _ P
m			II	X _ _
n			II	_ X _

* X : Option Selected
0 : Option Not Selected

2.4 Mounting

2.4.1 Physical Considerations

The controller can be mounted on either a vertical or tilted panel using the mounting bracket supplied. Adequate access space must be available at the back of the panel for installation and servicing activities.

- Overall dimensions and panel cutout requirements for mounting the controller are shown in Figure 2-1 through Figure 2-4

2.4.2 Overall Dimensions

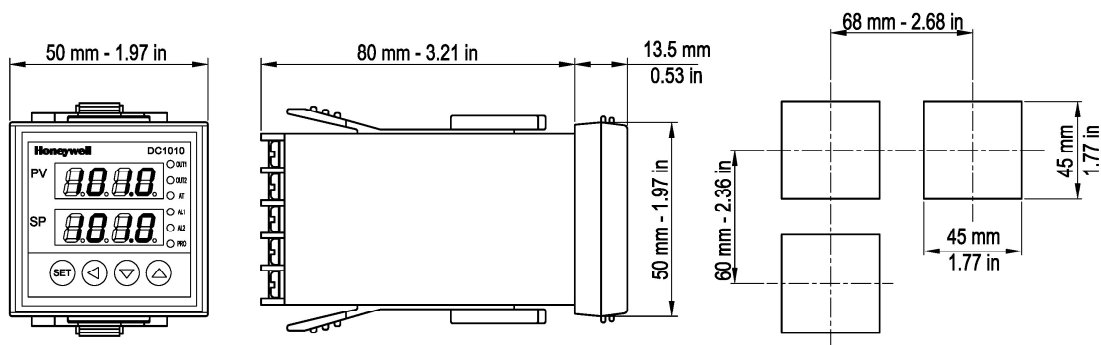

Figure 2-1 Model DC1010 Dimensions

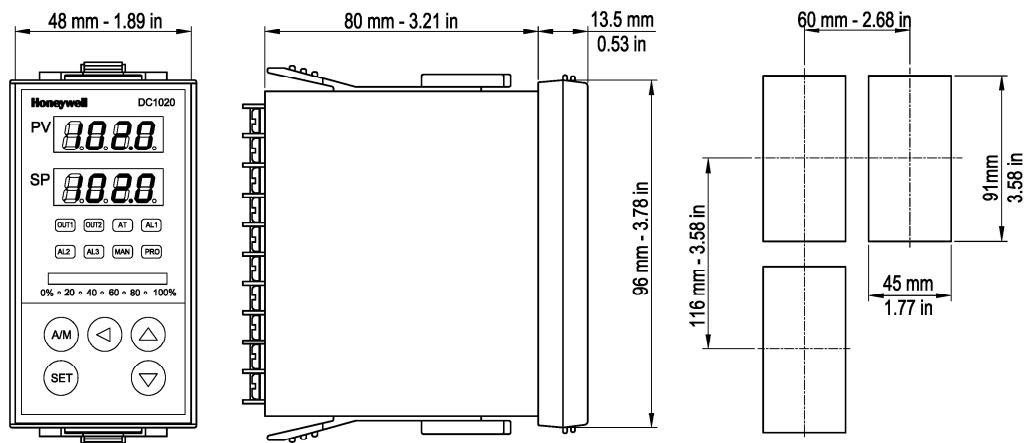

Figure 2-2 Model DC1020 Dimensions

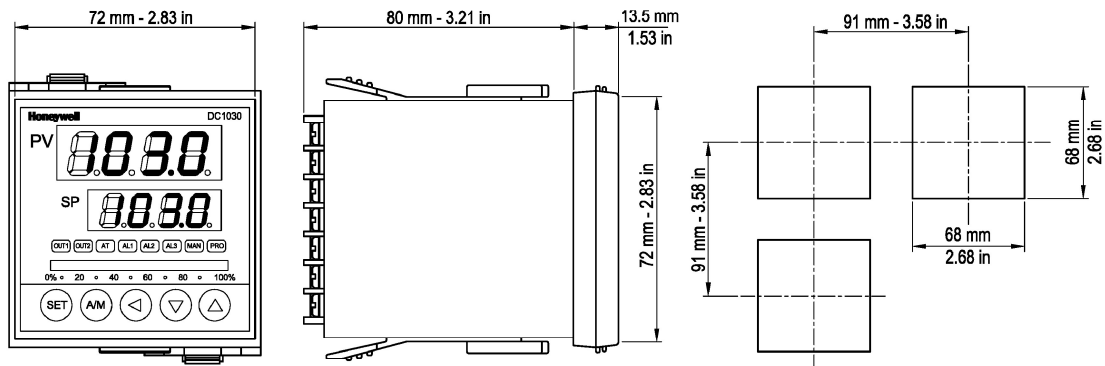

Figure 2-3 Model DC1030 Dimensions

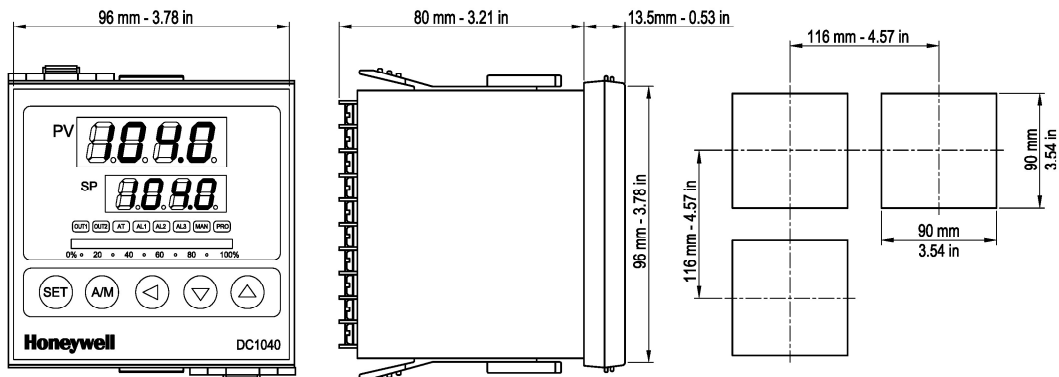
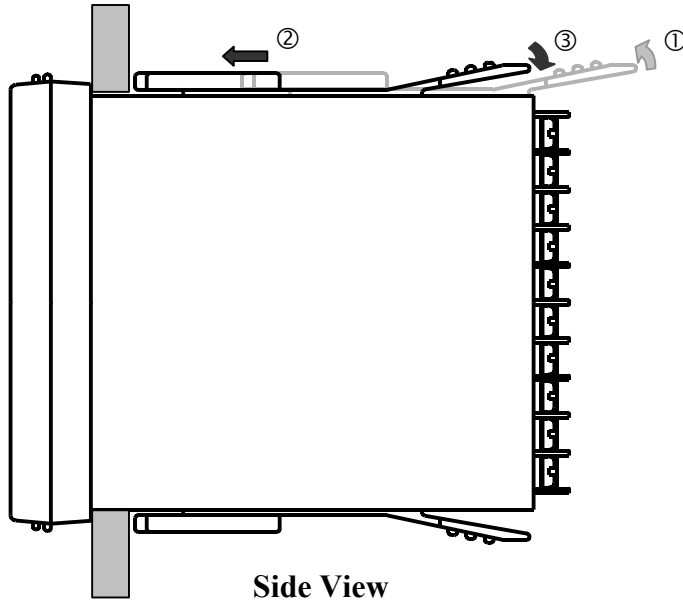

Figure 2-4 Model DC1040 Dimensions

2.4.3 Mounting Procedure

Before mounting the controller, refer to the nameplate on the outside of the case and make a note of the model number. It will help later when selecting the proper wiring configuration.



1. Put the mounting bracket in the rail on the top & bottom of the case.
2. Bend the grip of the bracket & slide the bracket along the rail until the case is secured against the panel.
3. Put the grip of the bracket on the groove to fasten the case to the panel.

Figure 2-5 Mounting Procedure

2.5 Wiring

2.5.1 Electrical Considerations

Precautions

The controller is considered “rack and panel mounted equipment” per EN61010-1, Safety Requirements for Electrical Equipment for Measurement, Control, and Laboratory Use, Part 1: General Requirements. Conformity with 72/23/EEC, the Low Voltage Directive requires the user to provide adequate protection against a shock hazard. The user shall install this controller in an enclosure that prevents the OPERATOR access to the rear terminals.

Mains Power Supply

This controller is suitable for connection to 100-240 Vac, 50/60 Hz or 15-50 Vdc, power supply mains. It is the user’s responsibility to provide a switch and non-time delay (North America), quick-acting, high breaking capacity, Type F(Europe), 1/2A, 250V fuse(s) or circuit breaker for 100-240Vac operation as part of the installation. The switch or circuit-breaker should be located close to the controller, within easy reach of the operator. The switch or circuit-breaker should be marked as the disconnecting device for the controller.

When applying power to multiple instruments, make sure that sufficient current is supplied. Otherwise, the instruments may not start up normally due to the voltage drop caused by the in-rush current.



Applying 100-240Vac to a controller rated for 15-50Vdc will severely damage the controller and is a fire and smoke hazard

2.6 Wiring Diagrams

2.6.1 Identify Your Wiring Requirements

To determine the appropriate diagrams for wiring your controller, refer to the model number interpretation in this section. The model number of the controller is on the outside of the case.

Shielded twisted pair cable are required for all Analog I/O, Process Variable, RTD, Thermocouple, dc millivolt, low level signal, mA, Digital Output, and computer interface circuits.

2.6.2 Making Terminal Connections

(1) Connection of power supply input terminal

- Type: Round
- Cable square: 1.25 mm(0.049 in)
- Diameter: 3.0 ~ 3.7 mm(0.118~ 0.145 in)

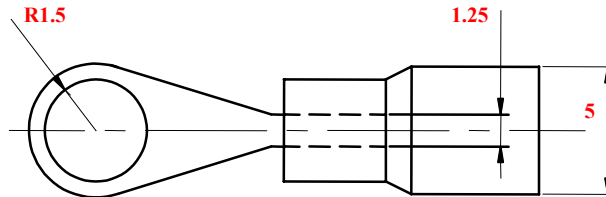

Terminal with tube(R, 1.25 * M3)

- Tighten the terminal screws using a torque between 0.8 N_m or less.

2.6.3 Wiring Diagrams

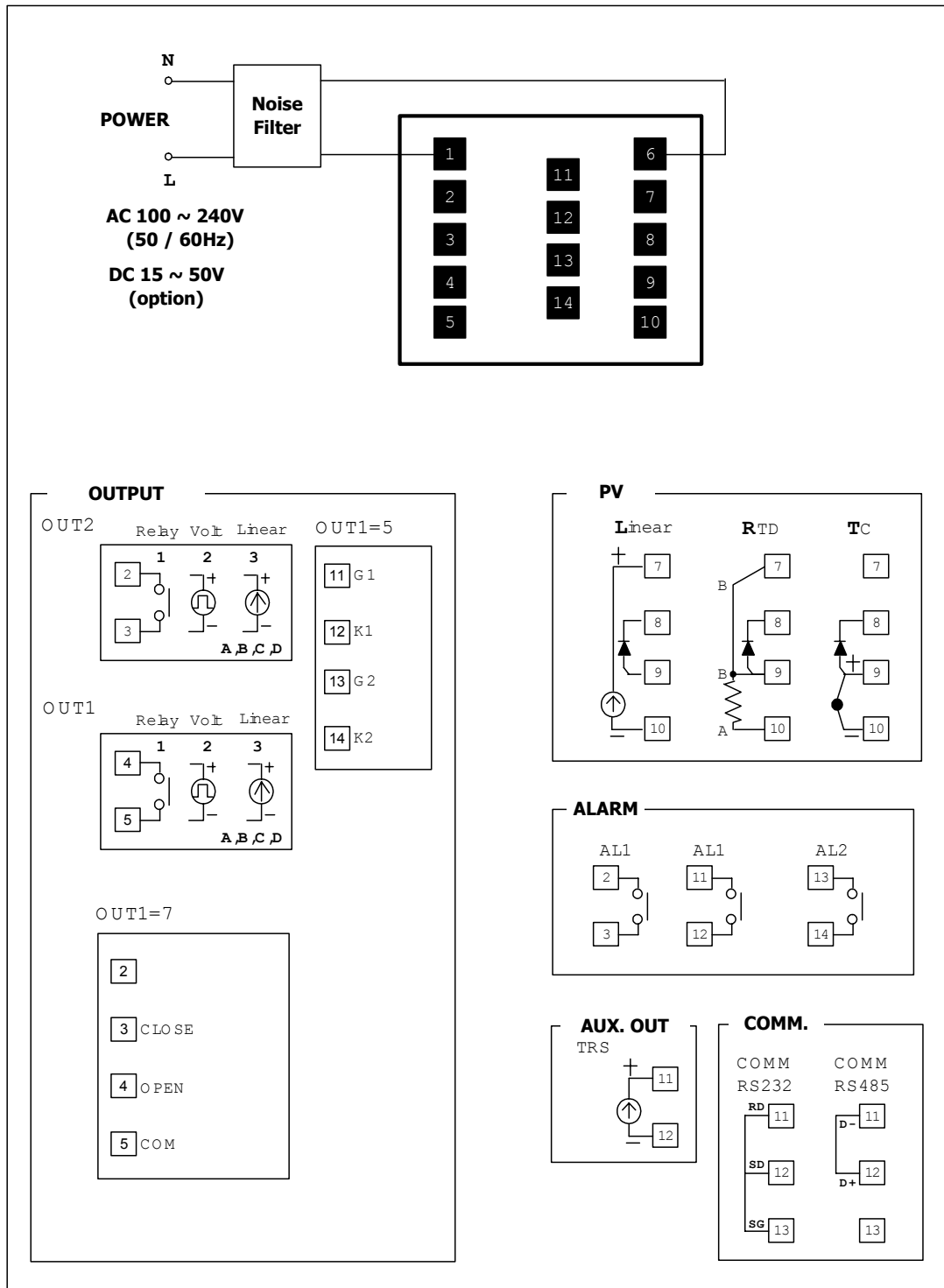

Figure 2-6 Model DC1010 Wiring

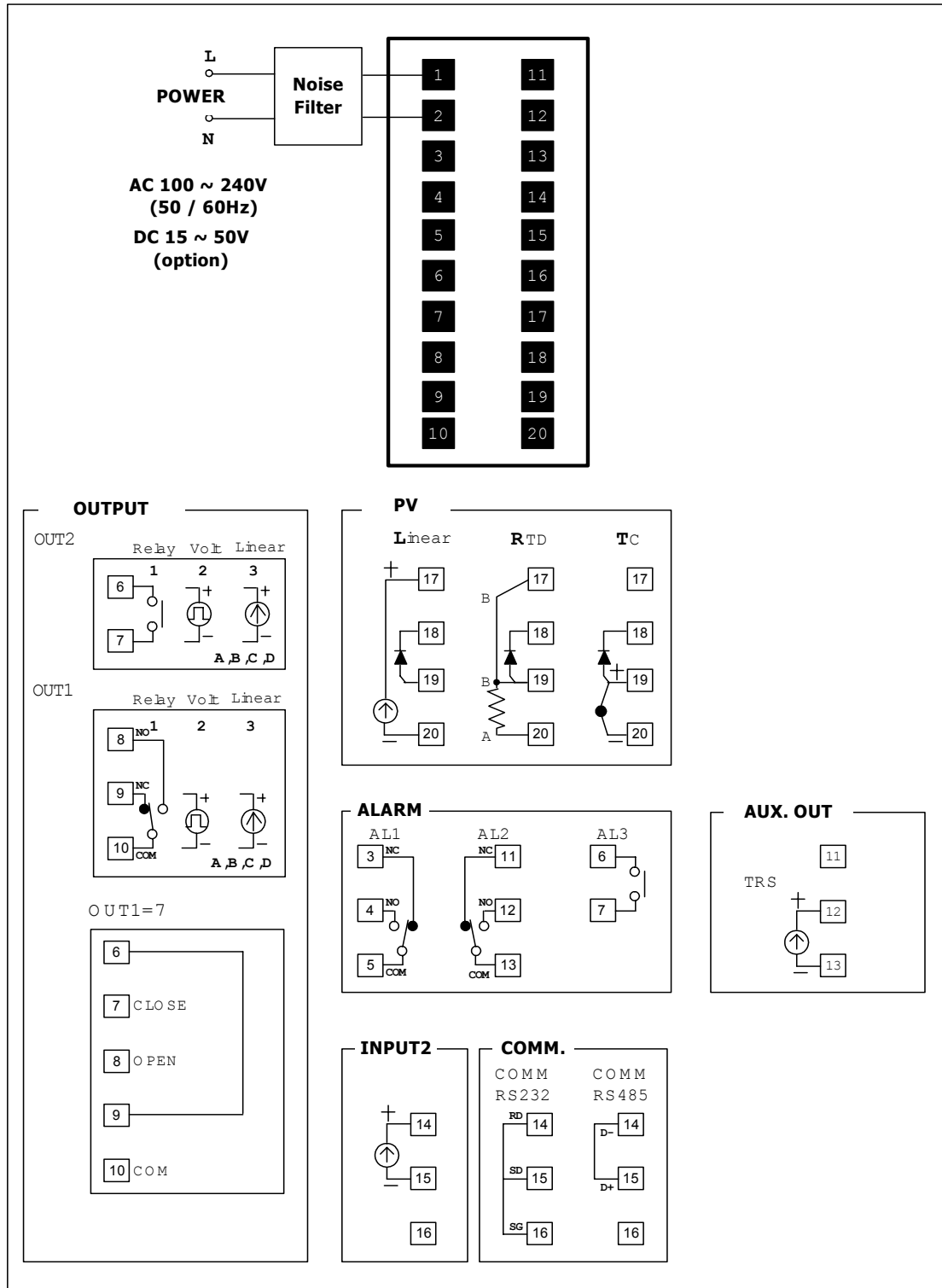

Figure 2-7 Model DC1020, DC1025 Wiring

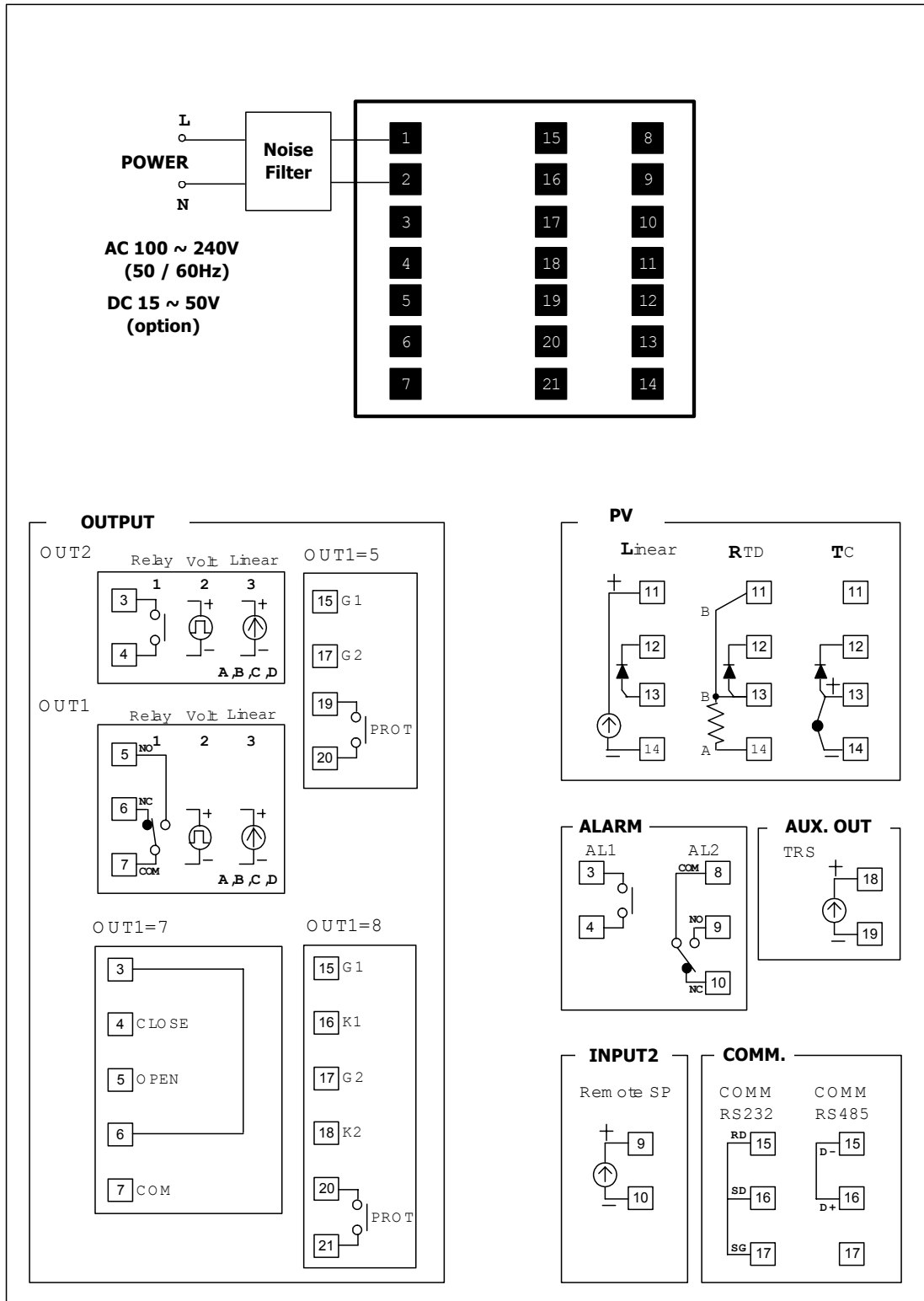

Figure 2-8 Model DC1030 Wiring

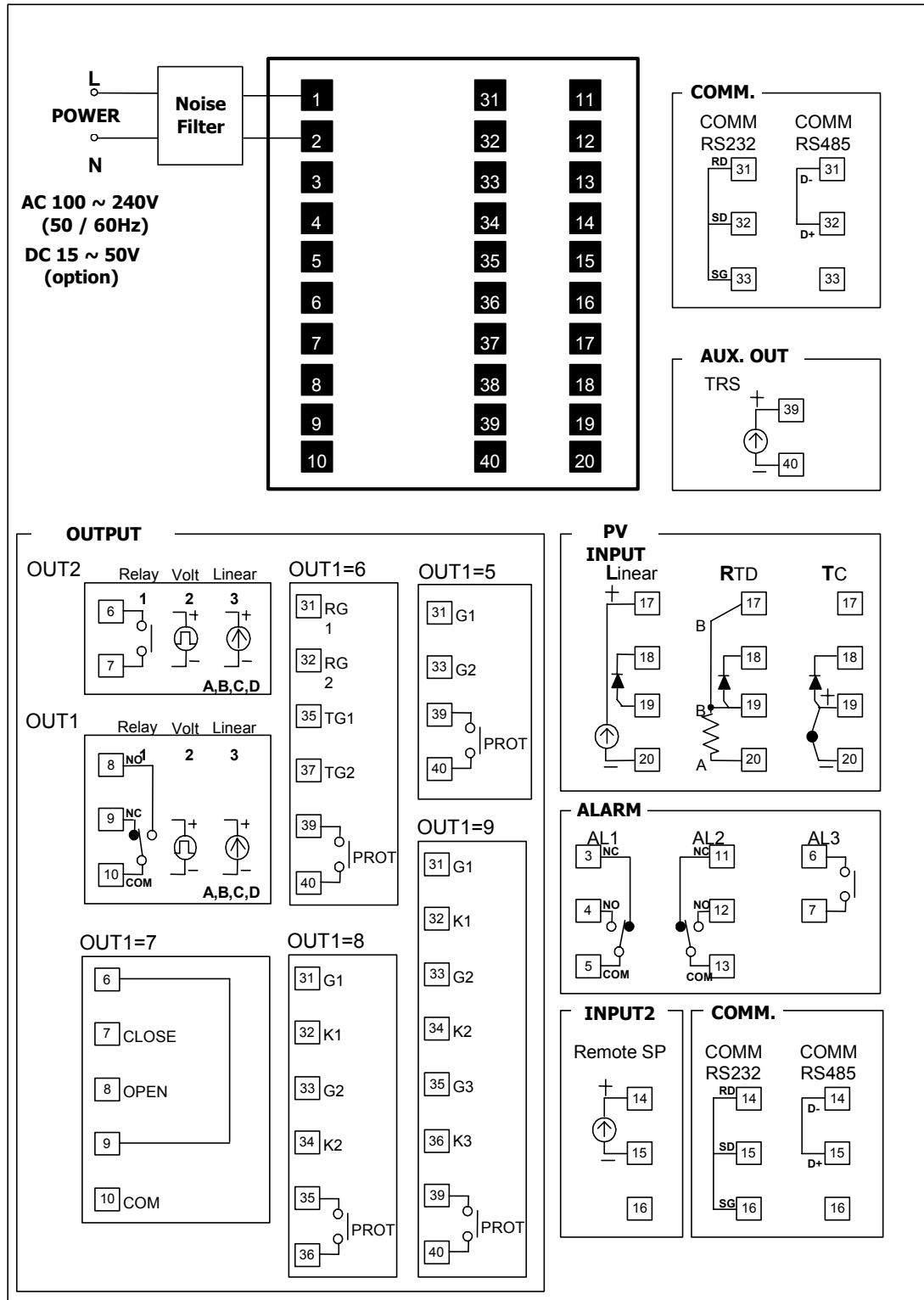

Figure 2-9 Model DC1040 Wiring

3 Operation

3.1 Overview

This section gives you all the information necessary to help you monitor and operate your controller including an Operator Interface overview, an explanation of the Displays, keys, and LEDs, and Mode access, and Operation Modes.

3.2 Operator Interface Overview

Figure 3-1 is a view of the operator interface. See Table 3-1 for a description of Displays, LEDs, and Keys.

Also, see section 4.5 to allow parameters to be hidden or displayed.

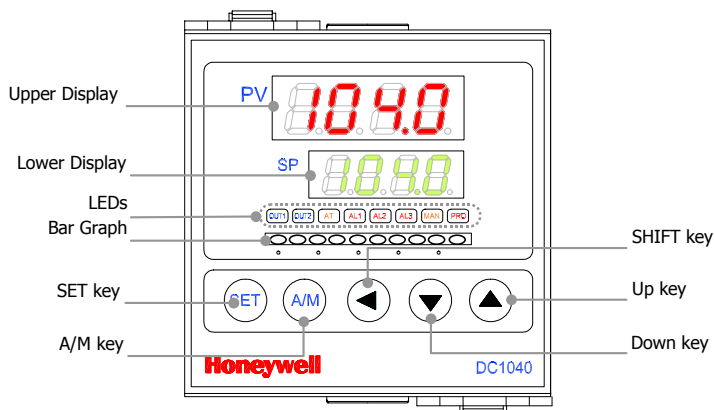

Figure 3-1 Operator Interface

3.2.1 Displays, LEDs, and Keys

Table 3-1 Displays, LEDs, and Keys

Displays	
Upper Display	4 digits dedicated to display the PV. In configuration mode, this display indicates the name of a parameter.
Lower Display	4 digits dedicated to display the SP. In configuration mode, this display indicates the value of a parameter or the status of the parameter selected
Bargraph	A 10 green LEDs' bargraph indicates the value of the output in percentage
LEDs	Indications
OUT 1	Status of 'Output 1'
OUT 2	Status of 'Output 2'
AT	When the LED is ON, it indicates that the controller is doing automatic tuning.
AL 1	Status of 'Alarm 1'
AL 2	Status of 'Alarm 2'
AL 3	Status of 'Alarm 3'
MAN	When the LED is ON, it indicates that the controller is in manual mode.
PRO	When a program is running, the LED flickers When a program is suspended, the LED is ON When no program is running, the LED is OFF
Keys	Function
SET	SET key allows moving from one parameter to another or saving a new value of a parameter or the status of a parameter changed.
A/M	A/M key allows switching from automatic mode to manual mode or from manual mode to automatic mode.
SHIFT	SHIFT key allows shifting the digits to modify parameters.
UP	Up key allows increasing the value of a digit selected or changing the status of a parameter.
DOWN	DOWN key allows decreasing the value of a digit selected or changing the status of a parameter.

3.3 Mode Access

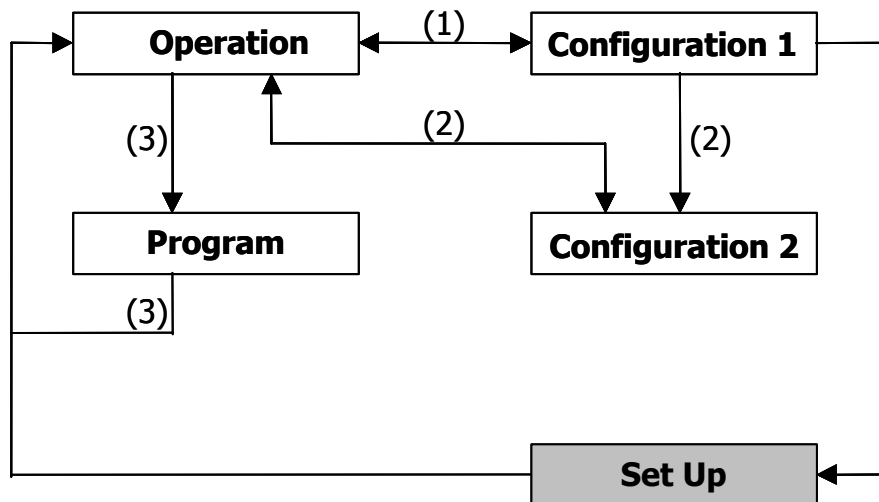

Figure 3-2 Mode Access Diagram

3.3.1 How to move from one mode to another

Refer to Figure 3-2 and Table 3-2 for instructions.

Table 3-2 Mode Change Instructions

Step	Action
(1)	Press 'SET' key for 5 seconds, it grants access to 'Configuration 1' mode or return to 'Operation' mode from 'Configuration 1' mode.
(2)	Press 'SHIFT' key for 5 seconds while pressing 'SET' key first, it grants access to 'Configuration 2' mode or return to 'Operation' mode.
(3)	All parameters related to program configuration will be displayed next to parameters in 'Operation' mode. (* These parameters will be shown in program model only)

ATTENTION Do not access 'set up' mode without technical assistance.

3.4 Operation Mode

3.4.1 Key Functions

3.4.1.1 Changing Parameter Value

Press the **SHIFT KEY** to change the parameters. If the **SHIFT KEY** is pressed, the first digit begins blinking. Press the **UP KEY** or **DOWN KEY** to increase or decrease the value of this digit, and then press the **SHIFT KEY** again to go to the next digit. As all the digits are written, press **SET KEY** to enter the value.

3.4.1.2 Changing Modes

SET KEY also has the function of changing **MODEs**. If the **SET KEY** is pressed, the display shows the next **MODE**.



If any key were not pressed for 1 minute, the display will return to Operation Mode.

Press the **A/M KEY** twice to go to **Operation Mode**, no matter what mode it's in.

If **OUTL** is set to "0", it means the controller has no output.

3.4.2 Operation Mode Prompts

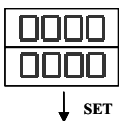
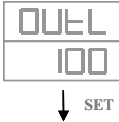
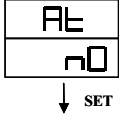
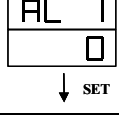
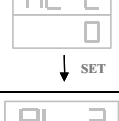
Table 3-3 Operation Mode Prompts

Displays	Parameter	Description
	PV Display SP Display	To change the setpoint value, see changing parameter values (paragraph 3.4.1.1). Press the "SET" key to save the value.
	Output Limit * Percentage (%)	For limiting the maximum value of Control Output Range: 0 to 100%
	Auto Tuning Status	Default "NO" ""YES" = Auto Tune Starts
	Alarm 1 Value of Alarm Setpoint	Depending on the Alarm Function selected, enter deviation value or absolute value. See Section 4.3.1 Alarm Function Selections
	Alarm 2 ** Value of Alarm Setpoint	Same as Alarm 1
	Alarm 3 ** Value of Alarm Setpoint	Same as Alarm 1
<p>Note: for programmer models, the prompts to configure the programs will appear after the operation mode prompts. See Section 5</p>		

*The 'OUTL' is not shown in default mode

**AL2' & 'AL3' are shown only in models with the relevant options.

3.4.3 Control Types

3.4.3.1 Manual Operation

In the manual mode, the operator directly controls the controller output level.

Press the “A/M” key until you see “OUTL” in the upper display and a fixed control output value in the lower display.

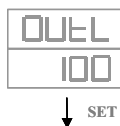

To change the value of the Output (%), refer to Paragraph 3.4.1.1 Changing Parameter Value.

Press the “SET” key to save the value.

3.4.3.2 ON/OFF Control

ON/OFF is the simplest control type. The output can be either ON (100 %) or OFF (0 %). The Process Variable (PV) is compared with the setpoint (SP) to determine the sign of the error ($ERROR = PV - SP$). The ON/OFF algorithm operates on the sign of the error signal.

The output type must be the relay output (DC10X0XX-1XX-XXX-X).

See ‘Configuration 1’ Mode (Table 4-1). Change ‘P’ value to 0. Until PV reaches SP, the control output is just ON (100%), and then the control output becomes OFF (0%).

* To prevent the control output from flickering too frequently, set the hysteresis ‘HYS1’ in ‘Operation’ mode (Table 3-3).

3.4.3.3 PID Control

PID control is the default control type of this controller.

PID is normally used for three-mode control. This means that the output can be adjusted somewhere between 100 % and 0 %. It applies all three control actions—Proportional (P), Integral (I), and Derivative (D)—to the error signal.

See ‘Configuration 1’ Mode (Table 4-1). Set the PID Values “P”, “I”, “D”, “db”, and “CYC”.

Auto Tuning

See ‘Operation’ Mode (Table 3-3). Set ‘AT’ prompt to ‘YES’. The auto tuning process will start. After the auto tuning is completed, the controller gets optimum PID values for the control system and starts the operation automatically.

Auto tuning allows the controller to automatically adjust the PID parameters, and is suitable for use when temperature control is not accurate enough.

See ‘Configuration 1’ Mode (Table 4-1). Prompt ATVL = auto tuning offset. It will be deducted from the Set Value [SV] (it can prevent overshoot during auto tuning)
 $SV - ATVL = \text{Auto-tuning value}$, $ATVL = \text{auto tuning offset}$

Example:

SV=200°C, ATVL=5, Auto tuning point is at 195°C

During auto tuning the PV value will oscillate around 195°C.

Hence the PV will not go over 200°C.

Note: In programmable model, ATVL means Auto-tuning point

Auto tuning failure

Possible cause 1: ATVL is too big. (If not sure, set ATVL = 0)

Possible cause 2: System time is too long. (Set PID parameter manually)

Fuzzy

Fuzzy Overshoot Suppression: The fuzzy logic observes the speed and direction of the PV signal as it approaches the setpoint and temporarily modifies the internal controller response action as necessary to avoid an overshoot. There is no change to the PID algorithm, and the fuzzy logic does not alter the PID tuning parameters.

See “Configuration 2” Mode (Table 4-2). Press the “A/M”key until you see:



↓SET

Select the “Fuzzy” code in the lower display.

3.4.4 Set Point

When power is applied, the default display is PV (Upper display) and Setpoint (Lower display).

See ‘Operation’ Mode (Table 3-3).

To change the setpoint value, see changing parameter values (paragraph 3.4.1.1).

Press the “SET” key to save the value.

3.4.5 Alarm Functions and Associated Prompts

Make sure each alarm is set properly.

- See “Configuration 2” Mode (Table 4-2). Set the required Alarm Code in prompts “Ald1”, “Ald2”, and “Ald3”.
Alarm Code: 00 to 19 (Table 4-3 Alarm Function Selections)
- See “Configuration 2” Mode (Table 4-2). Define the Alarm timing required for prompts “Alt1”, “Alt2”, and “Alt3”.
Range: 0-99 min, 59 seconds
0= flickering alarm, 99:59= continual alarm
Other = Time delay for alarm
- See “Operation” Mode (Table 3-3). Enter the deviation value or absolute value for prompts “Al1”, “Al2”, and “Al3” depending on the Alarm Code selected above.
- See “Configuration 2” Mode (Table 4-2). Set the hysteresis of alarms in prompt “HYSA”.

4 Configuration

4.1 Introduction







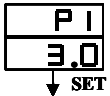
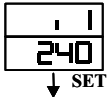
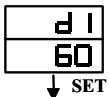
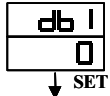
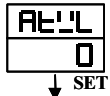

Configuration is a dedicated operation where you use straightforward keystroke sequences to select and establish (configure) pertinent control data best suited for your application. To assist you in the configuration process, there are prompts that appear in the upper and lower displays. Refer to Figure 3-1

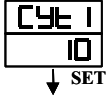
4.2 Configuration 1

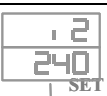
To access ‘Configuration 1’ mode, press the ‘SET’ key for 5 seconds while in ‘Operation’ mode (Section 3.4)

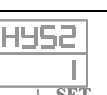
Table 4-1 Configuration 1 Mode

Displays Default Value Shown	Parameter	Description
	Main Control (OUT 1) P Value (Proportional Band)	<i>Proportional</i> - Regulates the controller’s output in proportion to the error signal (the difference between Process Variable and Setpoint).Range: 0 – 200% [For On/Off Control, set P1 = 0. The only other prompt required for setting is HYS 1]
	Main Control (OUT 1) I Value (Integral Value)	<i>Integral</i> - Regulates the controller’s output to the size of the error and the time the error has existed. (The amount of corrective action depends on the value of proportional Gain.) Range: 0 – 3200 seconds Integral off, I = 0
	Main Control (OUT 1) D Value (Derivative Time)	<i>Derivative</i> – Regulates the controller’s output in proportion to the rate of change of the error. (The amount of corrective action depends on the value of proportional Gain.) Range: 0 – 900 seconds Derivative off, D = 0
	Main Control Dead-Band Time	* DO NOT CHANGE THE VALUE
	Main Control (OUT 1) Auto Tuning Offset <i>For Programmer models- ATVL means Auto Tuning Point.</i>	Range: 0 – Upper Limit Value (USPL) Prevents Overshoot during Autotuning









Displays Default Value Shown	Parameter	Description
	Main Control (OUT 1) Cycle of Control Output	Output Type (SSR → 1, 4-20mA → 0, Relay → 10) Range: 0 to 150 seconds
	Main Control (OUT 1) Actuation of Hysteresis	For On/Off Control (P1=0) (Range 0-1000) ON: PV ≤ (SP – HYS1) OFF: PV > (SP + HYS1)
	Sub Control (OUT 2) * P Value (Proportional Band)	Same as P1 Configuration
	Sub Control (OUT 2) * I Value (Integral Value)	Same as I1 Configuration
	Sub Control (OUT 2) * D Value (Derivative Time)	Same as D1 Configuration
	Sub Control (OUT 2) * Cycle of Control Output	Same as CYT1 Configuration
	Sub Control (OUT 2) * Actuation of Hysteresis	Same as HYS1 Configuration
	Main Control (OUT 1) Gap	Control Output is turned off before reaching setpoint Turning Point = SP – GAP 1; Off = (OUT 1 = Heat)
	Sub Control (OUT 2) * Gap	Control Output is turned off before reaching setpoint Turning Point = SP + GAP 2; On = (OUT 2 = Cool)
	Function Lock	Refer to Section 4.4 for Mode access designations.

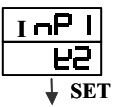
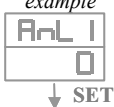

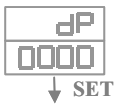

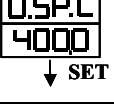

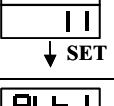
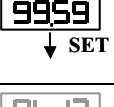

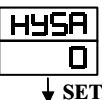

* Will only appear in models with “OUT2” option.

4.2.1 Configuration 2













To access ‘Configuration 2’ mode, press the ‘SHIFT’ key for 5 seconds WHILE pressing ‘SET’ key FIRST when in ‘Operation’ or ‘Configuration 1’ mode.

Table 4-2 Configuration 2 Mode

Displays Default Value shown except for examples	Parameter	Description
	Input 1 (INP1) Selection (Code)	Defines the Input type and Input range * Refer to Table 4-5, Table 4-6, and Table 4-7 for Input Codes
<i>example</i> 	Input 1 (INP1) Lower Limit of Linear input	Used during calibration of linear input * DO NOT change this value without technical assistance
<i>example</i> 	Input 1 (INP1) Upper Limit of Linear input	Used during calibration of linear input * DO NOT change this value without technical assistance
	Decimal Point	Used to set the position of the decimal point. Available for Linear Input only
	Lower Setpoint Limit	For Example: Linear Input = 4-20mA, when 4mA(0%), set the value for the lower limit
	Upper Setpoint Limit	For Example: Linear Input = 4-20mA, when 20mA(100%), set the value for the upper limit
	Input 2 (INP2) Lower Limit of Linear input	Used during calibration of linear input * DO NOT change this value without technical assistance
	Input 2 (INP2) Upper Limit of Linear input	Used during calibration of linear input * DO NOT change this value without technical assistance
	Alarm Code for Alarm 1	* Refer to Table 4-3 for Alarm Codes.
	Time set for Alarm 1	* Range: 0-99 min, 59 seconds 0= flickering alarm, 99:59= continual alarm Other = Time delay for alarm
	Alarm Code for Alarm 2	* Refer to Table 4-3 for Alarm Codes.

Displays Default Value shown except for examples	Parameter	Description
	Time set for Alarm 2	* Range: 0-99 min, 59 seconds 0= flickering alarm, 99:59= continual alarm Other = Time delay for alarm
	Alarm Code for Alarm 3	* Refer to Table 4-3 for Alarm Codes.
	Time set for Alarm 3	* Range: 0-99 min, 59 seconds 0= flickering alarm, 99:59= continual alarm Other = Time delay for alarm
	Hysteresis for alarms	Sets the hysteresis for alarm actuation (Range=0 to 1000) ON: $PV \leq (SP + HYS1)$ OFF: $PV > (SP + HYS1)$
<i>example</i> 	Main Control (OUT1) **0 Lower Limit of linear output	Used to adjust the linear control output during calibration * DO NOT change the value without technical assistance
<i>example</i> 	Main Control (OUT1) ** Upper Limit of linear output	Used to adjust the linear control output during calibration * DO NOT change the value without technical assistance
<i>example</i> 	Sub Control (OUT2) ** Lower Limit of linear output	Used to adjust the linear control output during calibration * DO NOT change the value without technical assistance
<i>example</i> 	Sub Control (OUT2) ** Upper Limit of linear output	Used to adjust the linear control output during calibration * DO NOT change the value without technical assistance
<i>example</i> 	Auxiliary Output Lower Limit of Aux. output	Used to adjust the linear control output during calibration * DO NOT change the value without technical assistance
<i>example</i> 	Auxiliary Output Upper Limit of Aux. output	Used to adjust the linear control output during calibration * DO NOT change the value without technical assistance
	Motor Time	Three Position Step Control - This is the time it takes the motor to travel from 0 to 100% (fully closed to fully open). This time can usually be found on the nameplate of the motor. Range: 5 – 200 seconds

Configuration

Displays Default Value shown except for examples	Parameter	Description
	Wait Function	To set "WAIT" for program operation
	Extra Set	DO NOT change the value of this parameter
	ID Number	Communication ID Number
	Baud Rate	DO NOT change the value of this parameter
	SP Compensation	Range: -1000 to 1000
	PV Compensation	Range: LSPL – USPL Used to Bias Process Variable
	Unit of PV and SP	Selection: C, F, and A (linear)
	Soft Filter	Adjusts the PV response time (Range: 0.05 to 1.00) (Larger value = faster response)
	* DO NOT change this value	
	Operation Mode (Control Action)	Heating or Cooling
	Control Process	PID or Fuzzy
	Frequency	50 or 60 Hz CAUTION: Make sure the proper frequency is selected.

** These two parameters are only for adjusting the linear signal of the control output, not for the limitation of the control output or any other purpose. DO NOT change these values without technical assistance.

4.3 ALARMS CONFIGURATION

4.3.1 Alarm Function Selections

These Alarm Function Selections are entered in “Configuration 2”. See Section 4.2.1.

Table 4-3 Alarm Function Selections

Code	Description	Hold-ON	Refer to
00 / 10	None		
01	Deviation high alarm	YES	Figure 4-2
11	Deviation high alarm	NO	Figure 4-3
02	Deviation low alarm	YES	Figure 4-4
12	Deviation low alarm	NO	Figure 4-5
03	Deviation high / low alarm	YES	Figure 4-6
13	Deviation high / low alarm	NO	Figure 4-7
04 / 14	Band alarm	NO	Figure 4-8 Figure 4-9
05	Absolute value high alarm	YES	Figure 4-11
15	Absolute value high alarm	NO	Figure 4-12
06	Absolute value low alarm	YES	Figure 4-13
16	Absolute value low alarm	NO	Figure 4-14
07	Segment end alarm (Use for program model only)	-	Paragraph 4.3.4.1
17	Program run alarm (Use for program model only)	-	Figure 4-15
08	System error alarm (On)	-	Figure 4-16
18	System error alarm (Off)	-	Figure 4-17
19	Soak timer	-	Paragraph 4.3.5.3

“Hold-On”(Blocking) means that the alarm does not work at the first time. The alarm signal is suppressed until the parameter gets to the non-alarm limit or band.

4.3.2 Deviation Alarm Overview

The Alarm SP (Set Point) is to be changed as the SP moves. In this case, the Alarm SP preserves a certain deviation value with the SP. When an alarm is set, a certain deviation value with the preset SP should be defined.

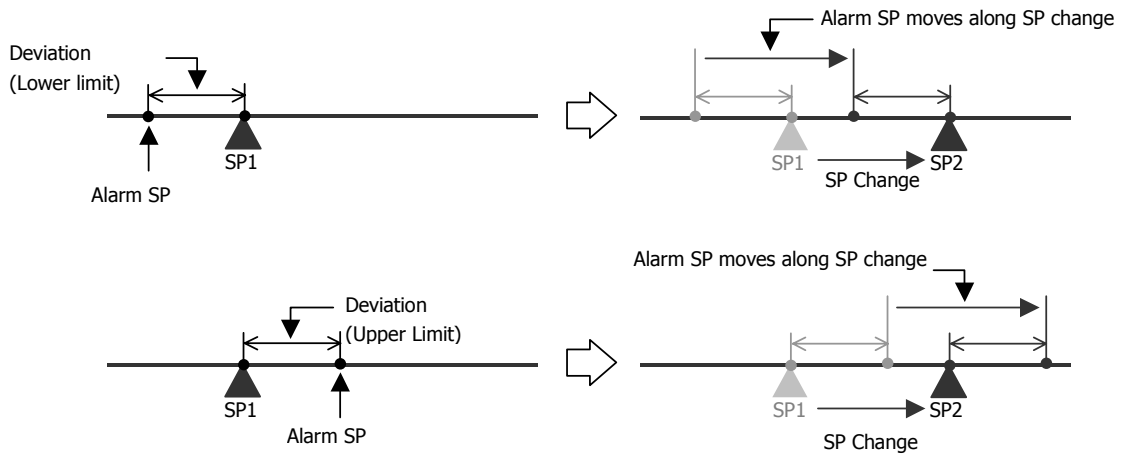

Figure 4-1 Deviation Alarms

4.3.2.1 Types of Deviation Alarms



Figure 4-2 Upper Limit Deviation Alarm [Hold On = Yes]
(Alarm Code 01, Alarm release in the first alarming situation)



Figure 4-3 Upper Limit Deviation Alarm
(Alarm Code 11, No alarm release in the first alarming situation)



Figure 4-4 Lower Limit Deviation Alarm
 (Alarm Code 02, Alarm release in the first alarming situation)



Figure 4-5 Lower Limit Deviation Alarm
 (Alarm Code 12, No alarm release in the first alarming situation)



Figure 4-6 Dev. Band Breakaway Alarm [Hold On = Yes]
 (Alarm Code 03, Alarm release in the first alarming situation)



Figure 4-7 Dev. Band Breakaway Alarm
 (Alarm Code 13, No alarm release in the first alarming situation)



Figure 4-8 Deviation Band Alarm [Hold On = Yes]
 (Alarm Code 04, Alarm release in the first alarming situation)



Figure 4-9 Deviation Band Alarm
 (Alarm Code 14, No alarm release in the first alarming situation)

4.3.3 Absolute Value Alarm Overview

The Alarm SP (Set Point) is to be fixed even though the SP moves. When an alarm is set, the absolute value of the Alarm SP should be defined.

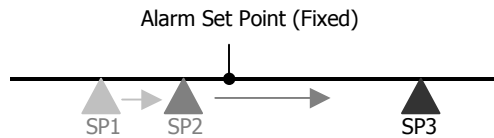

Figure 4-10 Absolute Value Alarm

4.3.3.1 Types of Absolute Value Alarms

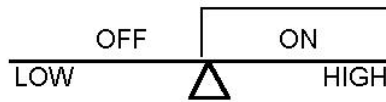

Figure 4-11 Absolute Upper Limit Alarm [Hold On = Yes]
(Alarm Code 05, Alarm release in the first alarming situation)

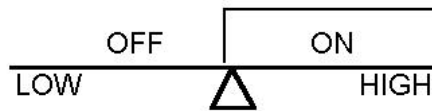

Figure 4-12 Absolute Upper Limit Alarm
(Alarm Code 15, No alarm release in the first alarming situation)

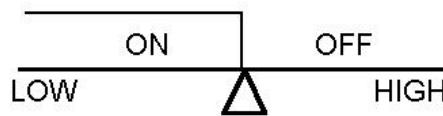

Figure 4-13 Absolute Lower Limit Alarm
(Alarm Code 06, Alarm release in the first alarming situation)



Figure 4-14 Absolute Lower Limit Alarm
(Alarm Code 16, No alarm release in the first alarming situation)

4.3.4 Program Alarm

4.3.4.1 Segment End Alarm (Alarm Code 07)

Once the selected segment is completed, the alarm becomes activated

- ALD1 – ALD3 Set the Alarm Code 07
- AL1 – AL3 Enter Segment No.for alarms
- ALT1 – ALT3 Define the alarm timing

(0= Flickering, 99.59 = Continuous, Others = Time Delay*)

* If ALD1-ALD3 is "07" (in other words, the alarm is set as "segment end alarm"), the ALT means how long the alarm is enabled (activated immediately and last during specified time).

* In case ALD1 - ALD3 is not "07" (in other words, the alarm is not set as "segment end alarm"), the ALT means "Time Delay".

4.3.4.2 Program RUN Alarm (Alarm Code 17)

While a program runs, the alarm becomes actuated

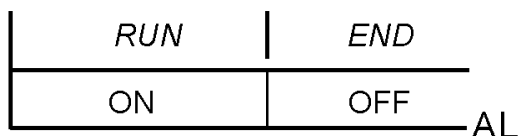

Figure 4-15 Program RUN Alarm – Code 17

4.3.5 System Alarm

4.3.5.1 System Error Alarm (Alarm Code 08)



Figure 4-16 System Error Alarm – Code 08

4.3.5.2 System Error Alarm (Alarm Code 18)

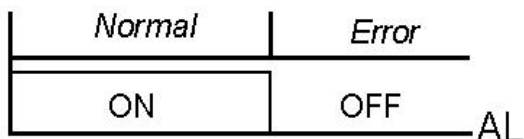

Figure 4-17 System Error Alarm – Code 18

4.3.5.3 Timer Alarm (Alarm Code 19)

Once the PV reaches the SP, the alarm becomes actuated after a certain time delay.

(Range: 00 hour 00 min – 99 hour 59 min)

4.4 Function Lock

According to the status of the parameter “LCK” in ‘Configuration 1’ mode, ‘access to modes’ and ‘change of values’ can be prohibited.

LCK=0000	MODE ACCESS-Access to ‘Operation’, Configuration1 & 2’ modes allowed (* Default)
LCK=0100	MODE ACCESS-Access to ‘Operation’ & ‘Configuration 1’ mode allowed VALUE CHANGE-Every value change in each mode allowed
LCK=0110	MODE ACCESS-Access to ‘Operation’ & ‘Configuration 1’ mode allowed VALUE CHANGE -Value changes only in ‘Operation’ mode allowed
LCK=0001	MODE ACCESS-Access to ‘Operation’ mode allowed VALUE CHANGE-Value change of SP (Set Point) allowed only
LCK=1111	MODE ACCESS-Access to “Set Up” mode allowed
LCK=0101	All access & value changes prohibited except the change of “LCK” status



CAUTION

Configuration should be performed only by personnel who are technically competent to do so. Local Regulations regarding electrical & safety must be observed.

4.5 Parameter Display Set (Hide or Display)

4.5.1 Overview

You can choose to hide or display some parameters by selecting the set mode of each. See Figure 4-18 Display Status for an interpretation of the Status of the Sets. Refer to Table 4-4 for Functions of the Sets.

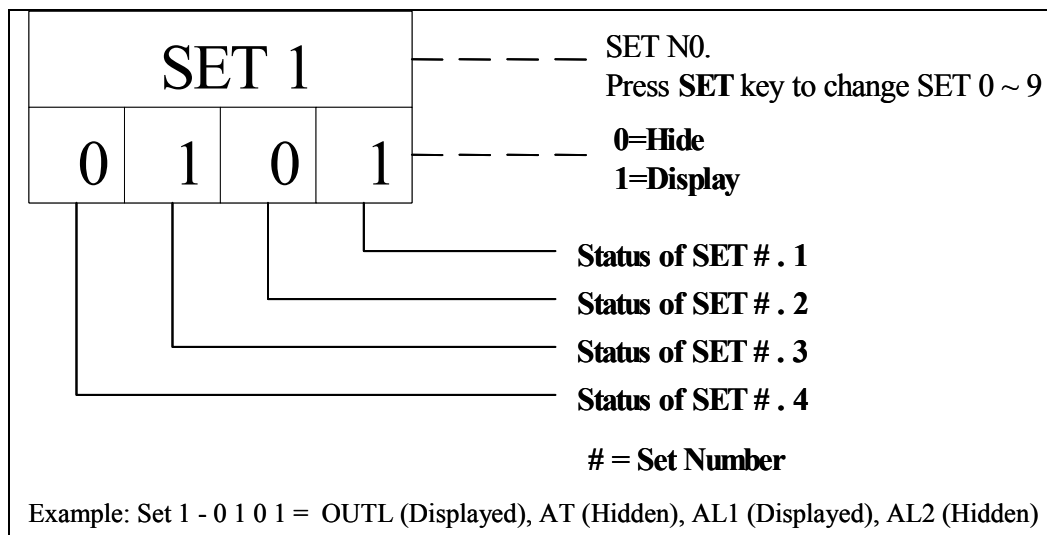

Figure 4-18 Display Status

4.5.2 Functions of SETs

Table 4-4 Functions of Sets

Set Number	Function	Set Number	Function
1.1	OUTL	5.1	CLO2, CHO2
1.2	AT	5.2	CLO3, CHO3
1.3	AL1	5.3	RUCY, WAIT, SETA
1.4	AL2	5.4	IDNO, BAUD
2.1	AL3	6.1	SVOS (SP Comp = 0 or 1)
2.2	ANL1, ANH1, DP	6.2	PVOS (PV Comp = 0 or 1)
2.3	LSPL, USPL	6.3	UNIT
2.4	ANL2, ANH2	6.4	SOFT
3.1	ALD1	7.1	CASC
3.2	ALT1	7.2	OULD
3.3	ALD2	7.3	OPAD
3.4	ALY2	7.4	HZ
4.1	ALD3		
4.2	ALT3		
4.3	HYSA		
4.4	CLO1, CHO1		

Set Number	Function	Remarks
8.1	0 = Not repeat	Programmer Model Only See Section 5.
	1 = Program repeat	
8.2	0 = No power failure option	
	1 = With power failure option	
8.3 (Note 1)	0 = Program starts at 0	
	1 = Program starts from PV	
8.4	DO NOT USE SET 8.4. SEE CAUTION BELOW	
9.2	0 = Displays the Working SP 1 = Displays the Target SP	Varying value per time is displayed For Programmer Models: 1 = The time unit is changed from HH:MM to MM:SEC
9.3	TRS SV	Auxiliary Output Use
9.4	TRS PV	
0.3	0 = No remote SV option	
	1 = Remote SV option	

Note 1: When SET 8.3=1, the Programmer Controller will initiate the SV value to the current PV value. It will be more energy efficient, and also decreases the time needed to achieve the desired SV value. The remaining time left to reach the SV value will be shown in the parameter “TIMR”. Hence the time of countdown is related to the PV value, not related to segment setting.

	<p>CAUTION DO NOT operate SET 8.4. – DO NOT set SET 8.4 to 1</p> <p>The PV LED will not display any values and the process will be confused. In this case, press the SHIFT key and change the setting to “XXX0”.</p>
---	---

4.6 Input Codes

4.6.1 Code Selection

It requires that the Input Code in 'Configuration 2' mode be selected properly before the operation starts. See Section 4.2.1 [Parameters Input 1 (INP1) and Input 2 (INP2)]

Table 4-5 Thermocouple Inputs

TYPE	CODE	RANGE	
K	E1	0.0~200.0°C	0.0~392.0°F
	E2	0.0~400.0°C	0.0~752.0°F
	E3	0~600°C	0~1112°F
	E4	0~800°C	0~1472°F
	E5	0~1000°C	0~1832°F
	E6	0~1200°C	0~2192°F
J	J1	0.0~200.0°C	0.0~392.0°F
	J2	0.0~400.0°C	0.0~752.0°F
	J3	0~600°C	0~1112°F
	J4	0~800°C	0~1472°F
	J5	0~1000°C	0~1832°F
	J6	0~1200°C	0~2192°F
R	r1	0~1600°C	0~2912°F
	r2	0~1796°C	0~3216°F
S	S1	0~1600°C	0~2912°F
	S2	0~1796°C	0~3216°F
B	b1	0~1820°C	0~3308°F
E	E1	0~800°C	0~1472°F
	E2	0~1000°C	0~1832°F
N	n1	0~1200°C	0~2192°F
	n2	0~1300°C	0~2372°F
T	t1	0.0~400.0°C	0.0~752.0°F
	t2	0.0~200.0°C	0.0~392.0°F
	t3	0.0~350.0°C	0.0~662.0°F
W	w1	0~2000°C	0~3632°F
	w2	0~2320°C	0~2372°F
PLII	PL1	0~1300°C	0~2372°F
	PL2	0~1390°C	0~2534°F
U	U1	-199.9~600.0°C	-199.9~999.9°F

TYPE	CODE	RANGE	
	U2	-199.9~200.0°C	-199.9~392.0°F
	U3	0.0~400.0°C	0.0~752.0°F
L	L1	0~400°C	0~752°F
	L2	0~800°C	0~1472°F

Table 4-6 RTD Inputs

TYPE	CODE	RANGE	
JIS Pt100	JP1	-199.9~600.0°C	-199.9~999.9°F
	JP2	-199.9~400.0°C	-199.9~752.0°F
	JP3	-199.9~200.0°C	-199.9~392.0°F
	JP4	0~200°C	0~392°F
	JP5	0~400°C	0~752°F
	JP6	0~600°C	0~1112°F
DIN Pt100	dP1	-199.9~600.0°C	-199.9~999.9°F
	dP2	-199.9~400.0°C	-199.9~752.0°F
	dP3	-199.9~200.0°C	-199.9~392.0°F
	dP4	0~200°C	0~392°F
	dP5	0~400°C	0~752°F
	dP6	0~600°C	0~1112°F
JIS Pt50	JP.1	-199.9~600.0°C	-199.9~999.9°F
	JP.2	-199.9~400.0°C	-199.9~752.0°F
	JP.3	-199.9~200.0°C	-199.9~392.0°F
	JP.4	0~200°C	0~392°F
	JP.5	0~400°C	0~752°F
	JP.6	0~600°C	0~1112°F

* The default of Input Code is 'DP3' for the model of RTD input type. (DC10X0XR-XXX-XXX-X)

Table 4-7 Linear Inputs

CODE	SIGNAL	INPUT TYPE	RANGE
AN4	0 - 50mV	0-20mA, 0-1V, 0-5V, 0-10V	-1999~9999
AN5	10 - 50mV	4-20mA, 1-5V, 2-10V	-1999~9999

*The default of Input Code is 'AN5' (4-20mA) for the model of linear input type.

(DC10X0XL-XXX-XXX-X)

* DO NOT change the input type without technical assistance because it requires some hardware changes on the input board in order to select a certain linear input type.

5 Programmer (Optional)

5.1 Overview

5.1.1 Introduction

The program function of DC1000 has 2 program patterns, and each program has Max. 8 segments. The programs can be linked for a continuous 16 segments.

The term “programming” is used here to identify the process for selecting and entering the individual ramp and soak segment data needed to generate the required setpoint versus time profile (also called a program).

A segment is a ramp or soak function which together make up a setpoint program. Setpoint Ramp/Soak Programming lets you configure 8 ramp and 8 soak segments to be stored for use as one program or several small programs. You designate the end segment to determine where the program is to stop.

Each segment can be defined as a period of “RAMP” or “SOAK” status.

5.2 Programmer Terminologies

Program: A pattern which consists of some segments





Segment: A RAMP segment or a SOAK segment

RAMP: A segment with changing SP

SOAK: A Status with fixed SP

5.3 Operating Key Functions

Table 5-1 Key Functions

Key	Function	Description
	START	Start a program, 'PRO' LED to be flickered during the running operation.
	WAIT	Suspend the running program. 'PRO' LED will be turned on.
 + SET	JUMP	Skip a current segment.
 + SET	RESET	Stop the program running. 'PRO' LED will be turned off

5.4 Program Functions

5.4.1 Program Running Alarm

ALD1 = 17

Alarm Operation: During the program running, Alarm 1 will become actuated

5.4.2 Segment Completion Alarm

ALD1 (Alarm Code for Alarm 1)= 07 (Segment End Alarm)

AL1 (Alarm Condition)= 2 ('2' means Segment No.) When segment 2 ends, AL1 will act.

ALT1 (Alarm Time) = 00.10

Alarm Operation Example: Once Segment 2 is completed, Alarm 1 will become actuated and will be on for 10 seconds

5.4.3 END Function

The DC1000 **does not have an END segment**, so that the program will complete all the segments if segments are defined. If the program procedure is less than 8 segments, set the 'OUT' of next segment to 0, then the program running will be ended right after the previous segment is completed. Otherwise, it will proceed for 8 or 16 segments

5.4.4 Linking Function

The program function of DC1000 has 2 program patterns, and each program has a maximum of 8 segments. You can link these two patterns to obtain a program of 16 segments (PTN = 0)

PTN=1 proceed pattern 1-contains 8 segments.

PTN=2 proceed pattern 2-contains 8 segments.

PTN=0 linking proceed pattern 1 and 2 - total 16 segments.*

(*Please configure PTN1 and PTN2 first, and then set PTN to 0 – See Table 5-3 Program Configuration Prompts)

5.4.5 Wait Function

Refer to “Wait” in Table 4-2 for Setting.

Wait = 0 No Wait

Wait = Others Program holds on WAIT state until $PV > (SV - WAIT \text{ setting})$

Example:

PV = 80

SV_1 = 100

WAIT = 2

When PV runs to 100 at segment 1, the program will hold until the $PV > 98$, then the program will run to segment 2.

continued

5.4 Program Functions (continued)

5.4.6 Other Functions

These other functions [Program Repeat, Power Failure Option, and Program Start from PV] are set through the SETS function (**Refer to Table 4-4 Functions of Sets**).

Table 5-2 Associated Program Functions

SET	Function	Remarks
8.1	0 = No Program Repeat 1 = Program Repeats	When SET 8.1 = 1, the program will repeat from beginning to end.
8.2	0 = No Power Failure Option 1 = With Power Failure Option	When SET 8.2 = 1, if power is lost before the “target” setpoint is reached, upon power recovery, the controller powers up with Setpoint = Current PV value and it automatically “Restarts” from setpoint = current PV value up to the original “target” setpoint.
8.3	0 = Program starts from 0 1 = Program starts from PV	When SET 8.3 = 1, the setpoint is set to the current PV value and the Program then starts from this value. The program will be more energy efficient, and also decrease the time needed to achieve the desired setpoint value. The remaining time left to reach the setpoint value will be shown in the parameter “TIMR” (See Table 5-3 Program Configuration Prompts). The time of countdown in this instance is related to the PV value, not the segment setting.



5.5 Program Configuration Prompts

5.5.1 Overview

The prompts to configure the programs will appear after the operation mode prompts. See Table 3-3. Also see Table 5-2 for Associated program functions.

5.5.2 Configuration

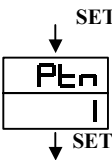
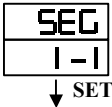
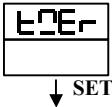
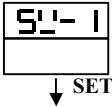
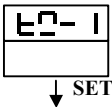
Table 5-3 Program Configuration Prompts

Displays	Parameter	Description
Start from Operation Mode – See Table 3-3		
	Program Pattern	Range: 0-2 PTN=1 proceed pattern 1-contains 8 segments. PTN=2 proceed pattern 2-contains 8 segments. PTN=0 linking proceed pattern 1 and 2 - total 16 segments. (Please set PTN1 and PTN2 at first, and then set PTN to 0)
	Program Segment Display	Lower Display = Pattern# — Segment# Example shown: Pattern 1 — Segment 1 Range: Pattern(1,2,0) — Segment(1~8)
	Program timer display	Range: 99hrs:59min Refer to Table 4-4 Functions of Sets to set the units of the Timer: SET 9.2 = 0 The unit of Timer is Hour:Minute SET 9.2 = 1 The unit of Timer is Minutes:Seconds
	Setpoint for Segment 1	Range: LSPL (Lower Setpoint Limit) to USPL (Upper Setpoint Limit) See Table 4-2 for Limit settings
	Time Setting for Segment 1	Range: 0-99 hrs:59 minutes Ramp segment* = Changing Setpoint time Soak segment** = Fixed Setpoint time
	Output Limit for Segment 1	Range: 0 to 100% If OUT = 0, program will end

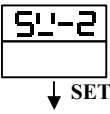
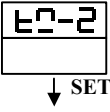
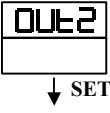
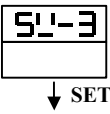
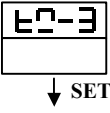
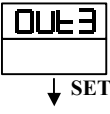
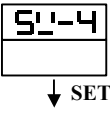
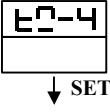
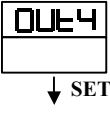
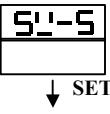
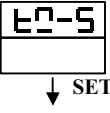
Displays	Parameter	Description
	Setpoint for Segment 2	Range: LSPL (Lower Setpoint Limit) to USPL (Upper Setpoint Limit) See Table 4-2 for Limit settings
	Time Setting for Segment 2	Range: 0-99 hrs:59 minutes Ramp segment* = Changing Setpoint time Soak segment** = Fixed Setpoint time
	Output Limit for Segment 2	Range: 0 to 100% If OUT = 0, program will end
	Setpoint for Segment 3	Range: LSPL (Lower Setpoint Limit) to USPL (Upper Setpoint Limit) See Table 4-2 for Limit settings
	Time Setting for Segment 3	Range: 0-99 hrs:59 minutes Ramp segment* = Changing Setpoint time Soak segment** = Fixed Setpoint time
	Output Limit for Segment 3	Range: 0 to 100% If OUT = 0, program will end
	Setpoint for Segment 4	Range: LSPL (Lower Setpoint Limit) to USPL (Upper Setpoint Limit) See Table 4-2 for Limit settings
	Time Setting for Segment 4	Range: 0-99 hrs:59 minutes Ramp segment* = Changing Setpoint time Soak segment** = Fixed Setpoint time
	Output Limit for Segment 4	Range: 0 to 100% If OUT = 0, program will end
	Setpoint for Segment 5	Range: LSPL (Lower Setpoint Limit) to USPL (Upper Setpoint Limit) See Table 4-2 for Limit settings
	Time Setting for Segment 5	Range: 0-99 hrs:59 minutes Ramp segment* = Changing Setpoint time Soak segment** = Fixed Setpoint time

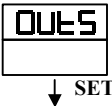
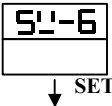
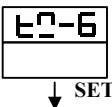
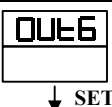
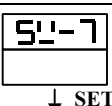
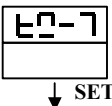
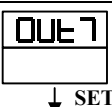
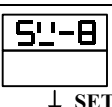
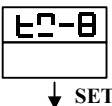
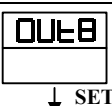
Displays	Parameter	Description
	Output Limit for Segment 5	Range: 0 to 100% If OUT = 0, program will end
	Setpoint for Segment 6	Range: LSPL (Lower Setpoint Limit) to USPL (Upper Setpoint Limit) See Table 4-2 for Limit settings
	Time Setting for Segment 6	Range: 0-99 hrs:59 minutes Ramp segment* = Changing Setpoint time Soak segment** = Fixed Setpoint time
	Output Limit for Segment 6	Range: 0 to 100% If OUT = 0, program will end
	Setpoint for Segment 7	Range: LSPL (Lower Setpoint Limit) to USPL (Upper Setpoint Limit) See Table 4-2 for Limit settings
	Time Setting for Segment 7	Range: 0-99 hrs:59 minutes Ramp segment* = Changing Setpoint time Soak segment** = Fixed Setpoint time
	Output Limit for Segment 7	Range: 0 to 100% If OUT = 0, program will end
	Setpoint for Segment 8	Range: LSPL (Lower Setpoint Limit) to USPL (Upper Setpoint Limit) See Table 4-2 for Limit settings
	Time Setting for Segment 8	Range: 0-99 hrs:59 minutes Ramp segment* = Changing Setpoint time Soak segment** = Fixed Setpoint time
	Output Limit for Segment 8	Range: 0 to 100% If OUT = 0, program will end
Back to "Operation" Mode – See Table 3-3		

*A **Ramp Segment** is the time it will take to change the setpoint to the next setpoint value in the program.

** A **Soak Segment** is a combination of soak setpoint (value) and a soak duration (time).

5.5.3 Program Example

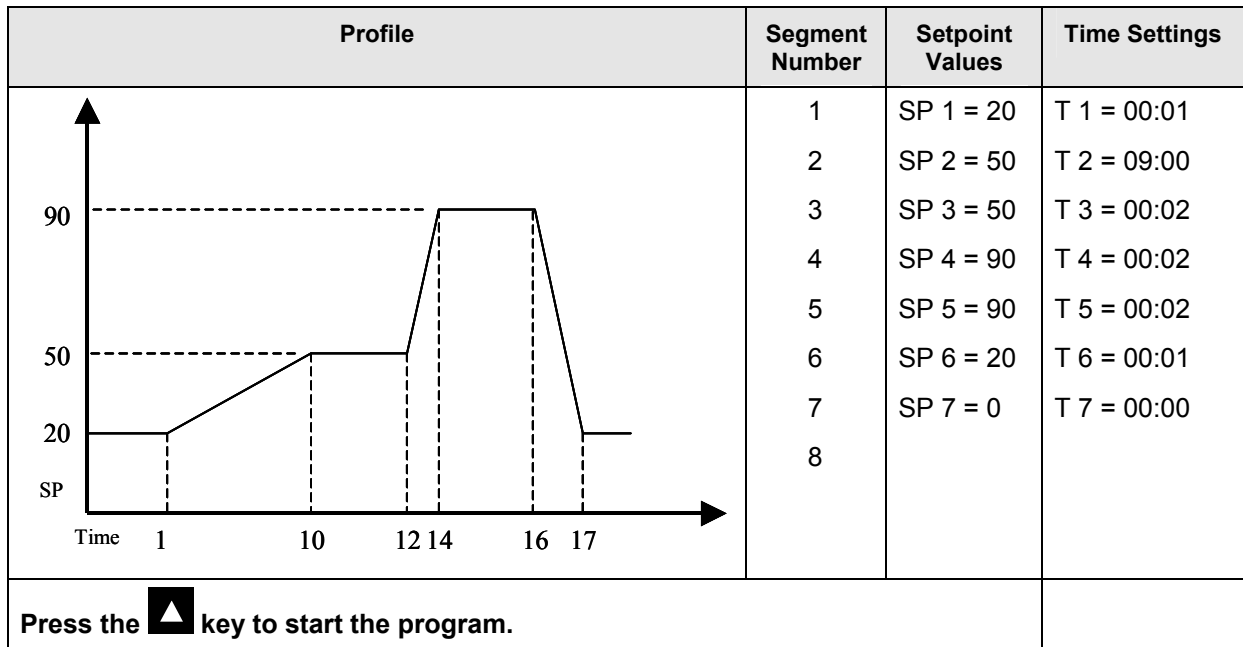

Figure 5-1 Program Example

6 Error Codes

6.1 Overview

Introduction

Instrument performance can be adversely affected by installation and application problems as well as by hardware problems. We recommend that you investigate the problems in the following order:

Table 6-1 Error Codes

ERROR CODE	DESCRIPTION	SOLUTION
1 n 1E	Open the circuit of 'INPUT 1' (sensor)	Check the wiring
A d C F (NOTE !)	A/D Convert Failure	Service Call required
C J C E (NOTE !)	Cold junction compensation failure	Service Call required
1 n 2 E	Open the circuit of 'INPUT 2' (sensor)	Check the wiring
u u u	Excess of PV over upper limit (INPUT 1)	- Check sensor wiring & input code - Adjust the range of indication
n n n	Shortage of PV under lower limit (INPUT1)	
n n n 2	Excess of PV over upper limit (INPUT2)	
n n n 2	Shortage of PV under lower limit (INPUT2)	
r H U T	Memory (RAM) failure	Service call required
1 n t F	Interface failure	Check wiring of input
A U t F	Auto tuning failure	Check wiring of output

NOTE 1: If one of these messages appear in the upper display of the controller, please check the points as described in the Solution column or call for technical service.

7 Index

A

Absolute Value Alarm Overview	32
Alarm 1	20
Alarm 2	20
Alarm 3	20
Alarm Code for Alarm 1	26
Alarm Code for Alarm 2	26
Alarm Code for Alarm 3	27
Alarm Function Selections	29
Alarm Functions	23
Alarms Configuration	29
Associated Program Functions	43
Auto Tuning	20, 21
Auto Tuning Offset	24
Auxiliary Output	27, 36

B

Baud Rate	28
Blocking	29

C

CE Conformity (Europe)	2
Changing Modes	20
Changing Parameter Value	20
Communication ID Number	28
Configuration	24
Configuration 1 Mode	24
Configuration 2 Mode	26
Control Algorithms	1
Control Process	28
Control Types	21
Cycle of Control Output	25

D

Dead-Band Time	24
Decimal Point	26
Derivative Time	24, 25
Deviation Alarm Overview	30
Dimensions	8
Display Status	35
Displays, LEDs, and Keys	18

E

Electrical Considerations	11
END Function	42
Error Codes	48

F

Frequency	28
Functions of SETs	35
Fuzzy Overshoot Suppression	22

G

Gap	25
-----------	----

H

Hysteresis	25
Hysteresis for alarms	27

I,J

Input 1	26
Input 2	26
Input Codes	37
Installation	3
Integral Value	24, 25

K

Key Functions	20
---------------------	----

L

Linear Inputs	39
Linking Function	42
Lock	25, 34
Lower Limit of Aux. output	27
Lower Limit of Linear input	26
Lower Limit of linear output	27

M,N

Main Control (OUT 1)	24
Main Control (OUT1)	27
Mains Power Supply	11
Manual Operation	21
Mode Access	19
Mode Change Instructions	19
Model DC1010 Dimensions	8
Model DC1010 Wiring	13
Model DC1020 Dimensions	8
Model DC1020, DC1025 Wiring	14
Model DC1030 Dimensions	9
Model DC1030 Wiring	15
Model DC1040 Dimensions	9
Model DC1040 Wiring	16
Model Number Interpretation	6
Motor Time	27
Mounting	8
Mounting Procedure	10

O

ON/OFF Control	21
Operating Key Functions	41
Operation	17
Operation Mode	20, 28
Operation Mode Prompts	20
Operator Interface Overview	17
Output Limit	20
Output Limit for Segment	44
Overview	1

P,Q

Parameter Display Set (Hide or Display)	35
Physical Considerations.....	8
PID Control	21
Power Failure Option	43
Pre-installation Information.....	3
Program Alarm	33
Program Configuration Prompts.....	44
Program Example	47
Program Functions.....	42
Program Pattern	44
Program Repeat	43
Program Repeats.....	43
Program RUN Alarm.....	33
Program Running Alarm	42
Program Segment Display	44
Program Start from PV	43
Program starts from PV	43
Program timer display	44
Programmer	36
Programmer (Optional).....	41
Programmer Terminologies.....	41
Proportional Band.....	24, 25
PV Compensation	28
PV Display	20

R

Ramp Segment.....	46
RTD Inputs	38

S

Segment Completion Alarm	42
Segment End Alarm.....	33
Set Point	22
Setpoint for Segment	44
Setpoint Limit	26
Soak Segment	46
Soft Filter.....	28
SP Compensation.....	28
SP Display	20
Specifications	4
System Alarm	33
System Error Alarm.....	33

T

Terminal Connections.....	12
Thermocouple Inputs.....	37
Three Position Step Control	27
Time set for Alarm 1	26
Time set for Alarm 2	27
Time set for Alarm 3	27
Time Setting for Segment.....	44
Timer Alarm	33
Types of Absolute Value Alarms	32
Types of Deviation Alarms.....	30

U,V

Upper Limit of Aux. output.....	27
Upper Limit of Linear input	26

W,X,Y,Z

Wait Function	28, 42
Wiring.....	11
Wiring Diagrams	12

Honeywell

Industrial Measurement and Control

Honeywell Korea
191 HanGangRo 2ga, YongSanGu
Seoul, Korea